



WHEEL / WHEEL AXLE REPLACEMENT INSTRUCTIONS

⚠ WARNING: GENUINE WEBER-STEPHEN REPLACEMENT PARTS MUST BE USED FOR ANY REPAIR OR REPLACEMENT. YOUR ACTIONS, IF YOU FAIL TO FOLLOW THIS PRODUCT WARNING, MAY CAUSE A STRUCTURAL FAILURE, OR FIRE RESULTING IN SERIOUS PERSONAL INJURY OR DAMAGE TO PROPERTY.

(WILL VOID ALL WARRANTY PROTECTION)

⚠ IMPORTANT NOTE: REMOVE LID AND GRATES BEFORE PERFORMING ANY WORK. MAKE SURE THE BARBECUE IS COLD AND ALL CHARCOAL RESIDUE IS REMOVED FROM THE KETTLE BOWL AREA.

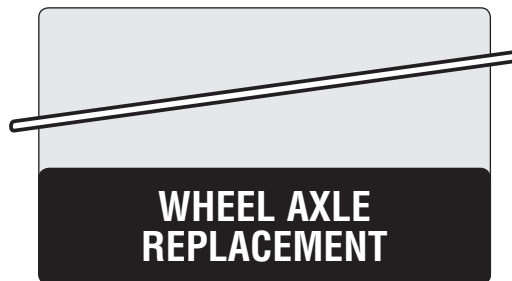
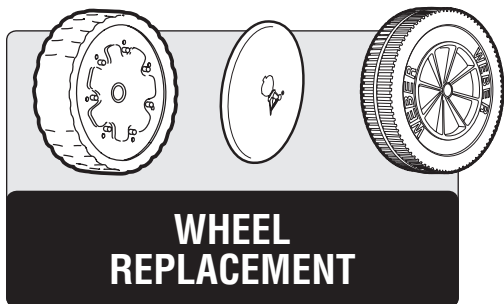

1 WHEEL COVER REMOVAL

TOOLS NEEDED:

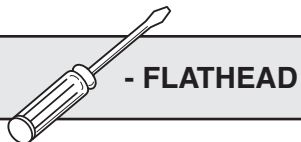

A) Remove both wheel covers with a flathead screwdriver.

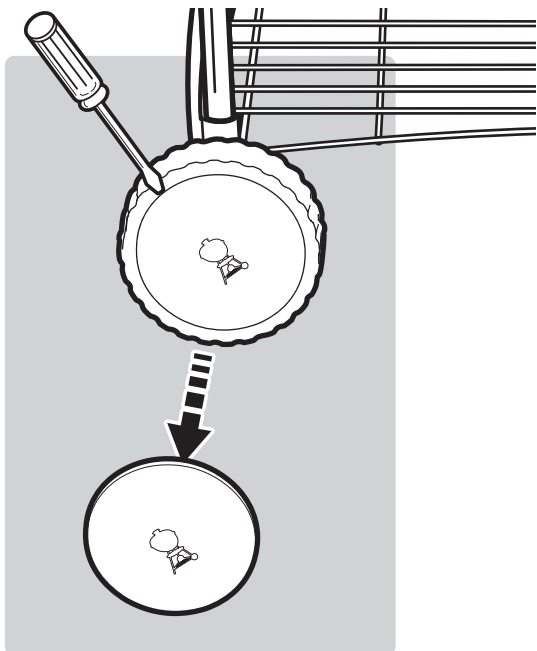

2 HUB CAP REMOVAL

TOOLS NEEDED:



A) Remove the wheel hub cap with a pair of pliers.
B) Twist back and forth until the wheel hub cap is completely removed (1 & 2).

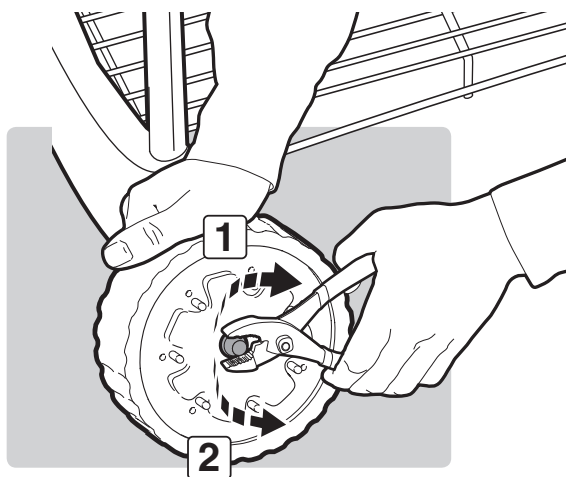

NOTE: The grills illustrated may have slight differences than the model purchased.

56174_01/06/12 **DE**

3

WHEEL & AXLE REMOVAL

- A) Pull the wheel off the axle (1).
- B) Slide the axle and attached wheel out of the frame assembly (2).
- C) Slide the other wheel off the axle (3).

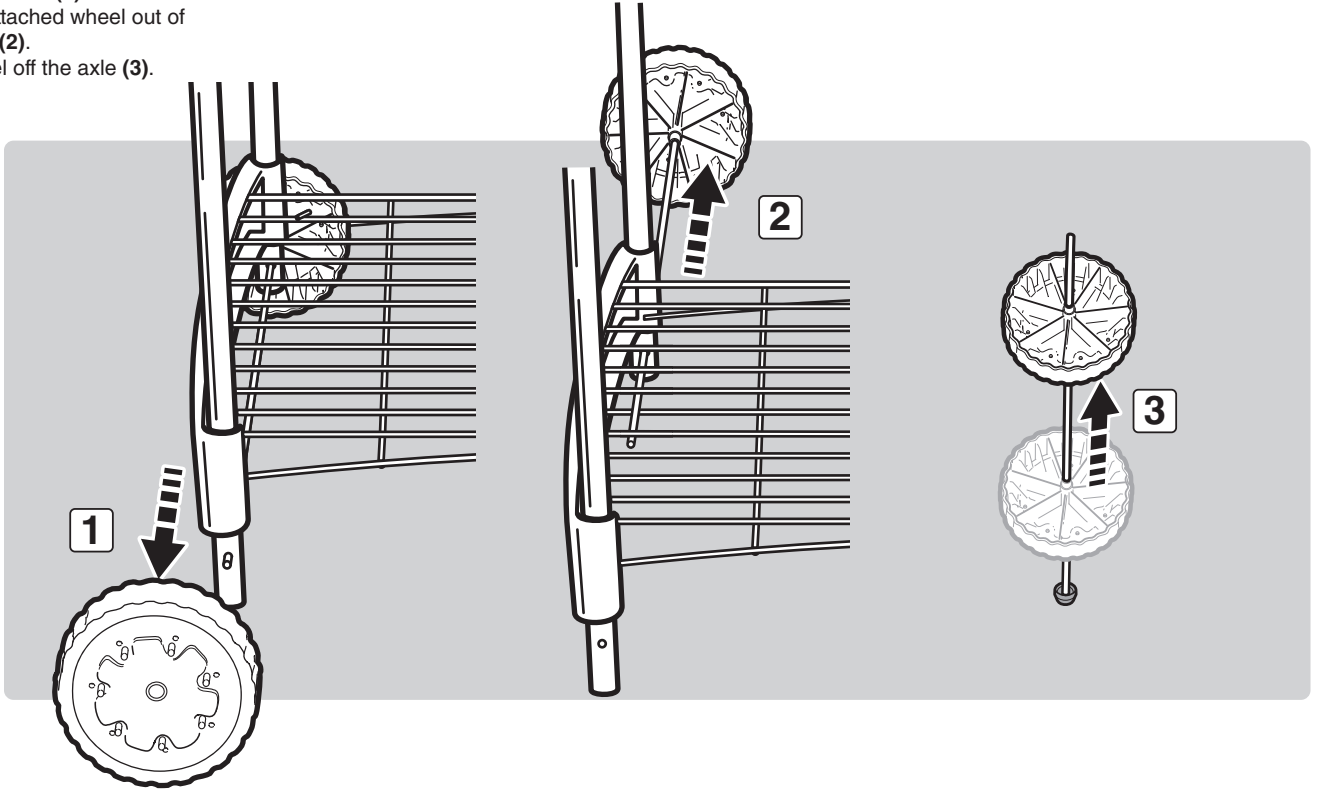

4

HUB CAP, AXLE & WHEEL INSTALLATION

TOOLS NEEDED:

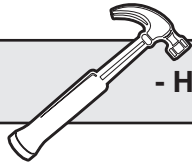

- HAMMER

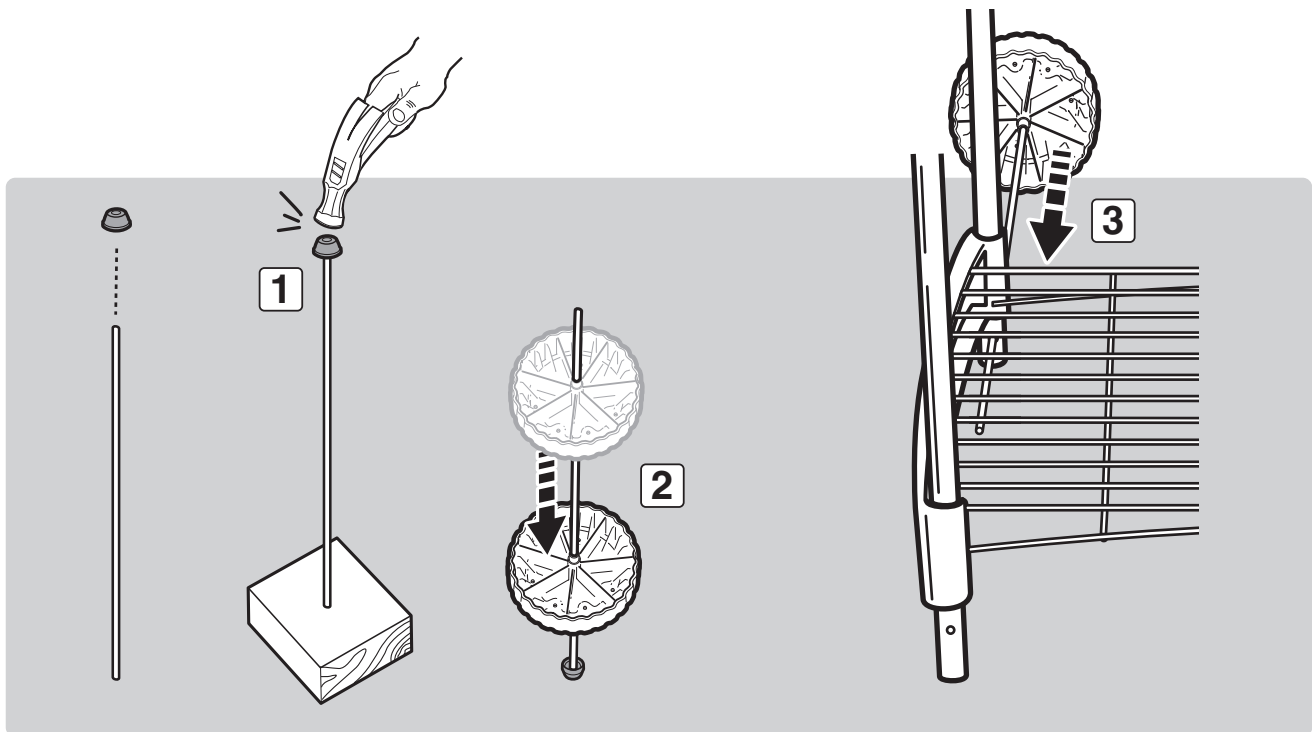

5

WHEEL & HUBCAP INSTALLATION

TOOLS NEEDED:

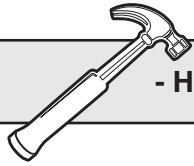

- HAMMER

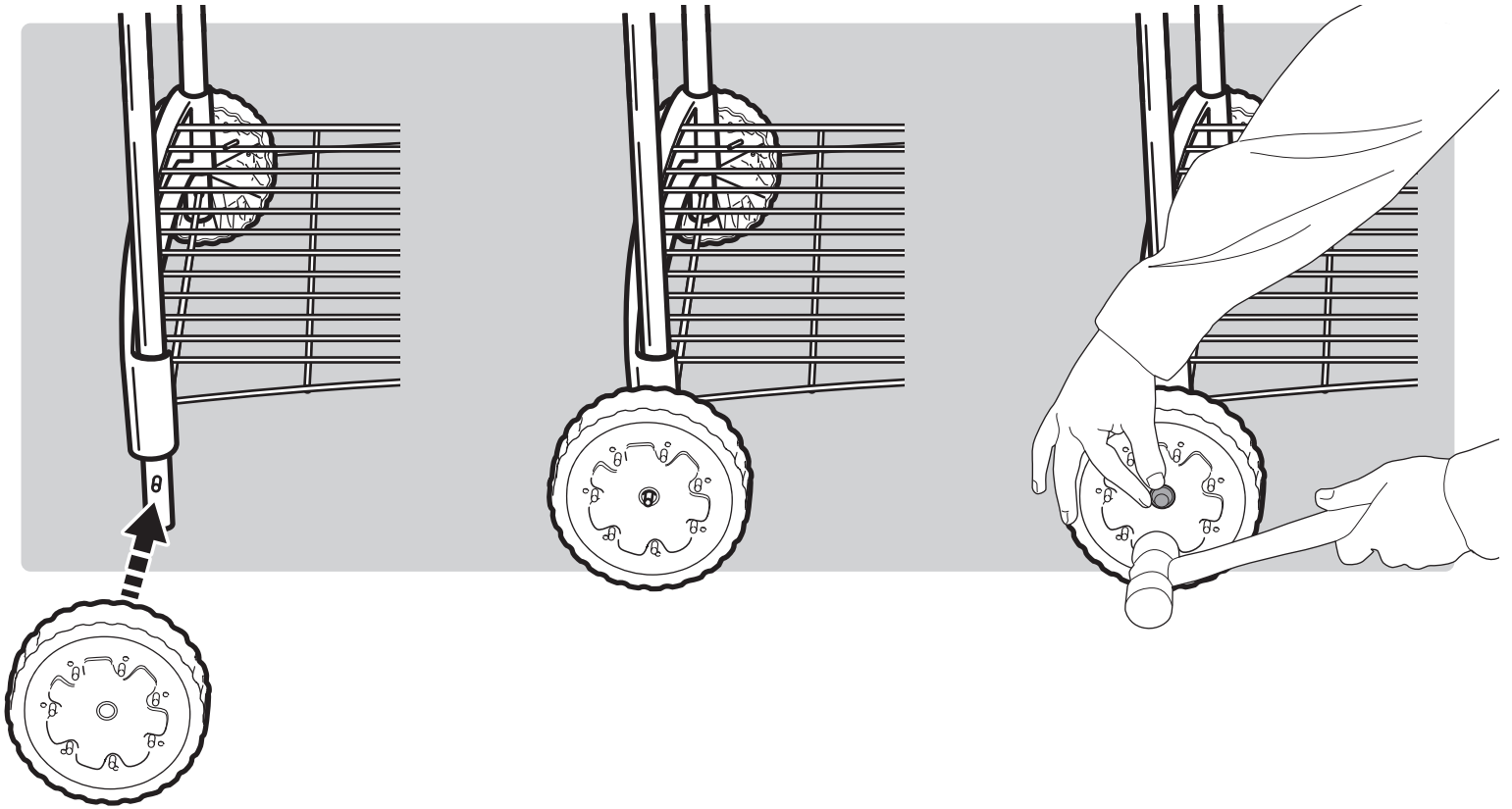

6

WHEEL COVER INSTALLATION

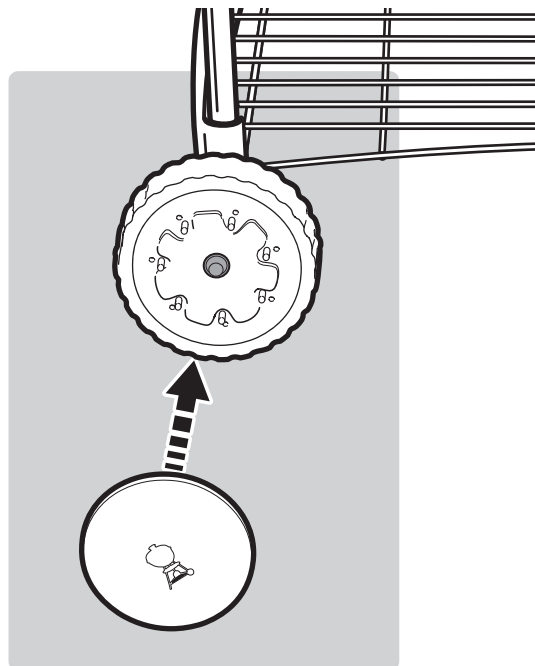

⚠ WARNING: Make sure that all parts are assembled and hardware is fully tightened before operating the grill. Your actions, if you fail to follow this Product Warning, may cause a structural failure, or fire resulting in serious personal injury or damage to property.



**WEBER-STEPHEN PRODUCTS LLC
Customer Service Center
1890 Roselle Road, Suite 308
Schaumburg, IL 60195**

**1-800-446-1071 (USA ONLY)
www.weber.com[®]**

Contact the Customer Service Representative in your area using the contact information on our website.